

---

# Table of Contents

## E65/66 Air Suspension

Subject	Page
<b>Single Axle Air Suspension (E65/E66)</b> .....	<b>.2</b>
Purpose of the System .....	.2
Components (E65/E66) .....	.4
Air Supply Unit (LVA) .....	.4
Control Unit .....	.5
Air Springs .....	.6
Ride Height Sensor .....	.7
Control Mode Flow Chart .....	.8
<b>Principle of Operation</b> .....	<b>.9</b>
Control Mode Overview .....	.9
Control Modes .....	.9
Sleep .....	.9
Post Mode .....	.10
Pre-Mode .....	.10
Normal .....	.11
Drive .....	.11
Kerb (Curb) Mode .....	.12
Curve .....	.12
Lift .....	.13
Transport .....	.13
Belt .....	.13
<b>Operating Principle</b> .....	<b>.14</b>
Initialization/Reset Performance .....	.14
Control Sequence .....	.14
<b>Safety Concept</b> .....	<b>.15</b>
<b>Workshop Hints</b> .....	<b>.16</b>
<b>Diagnosis</b> .....	<b>.17</b>
<b>Service Functions</b> .....	<b>.17</b>

## Single Axle Air Suspension (E65/E66)

### Purpose of the System

The single axle air suspension system used on the the E65/E66 is a further enhancement of the previous single axle air suspension system used on the the E39 and X5. The components used are similar to the Single Axle EHC System on the E53. The E65/E66 Air suspension consists of the following components:

- Air Supply System (LVA)
- Control Unit (EHC)
- Two Air Springs
- Two Ride Height Sensors
- CC Display/Telltale Icon



KT-10508

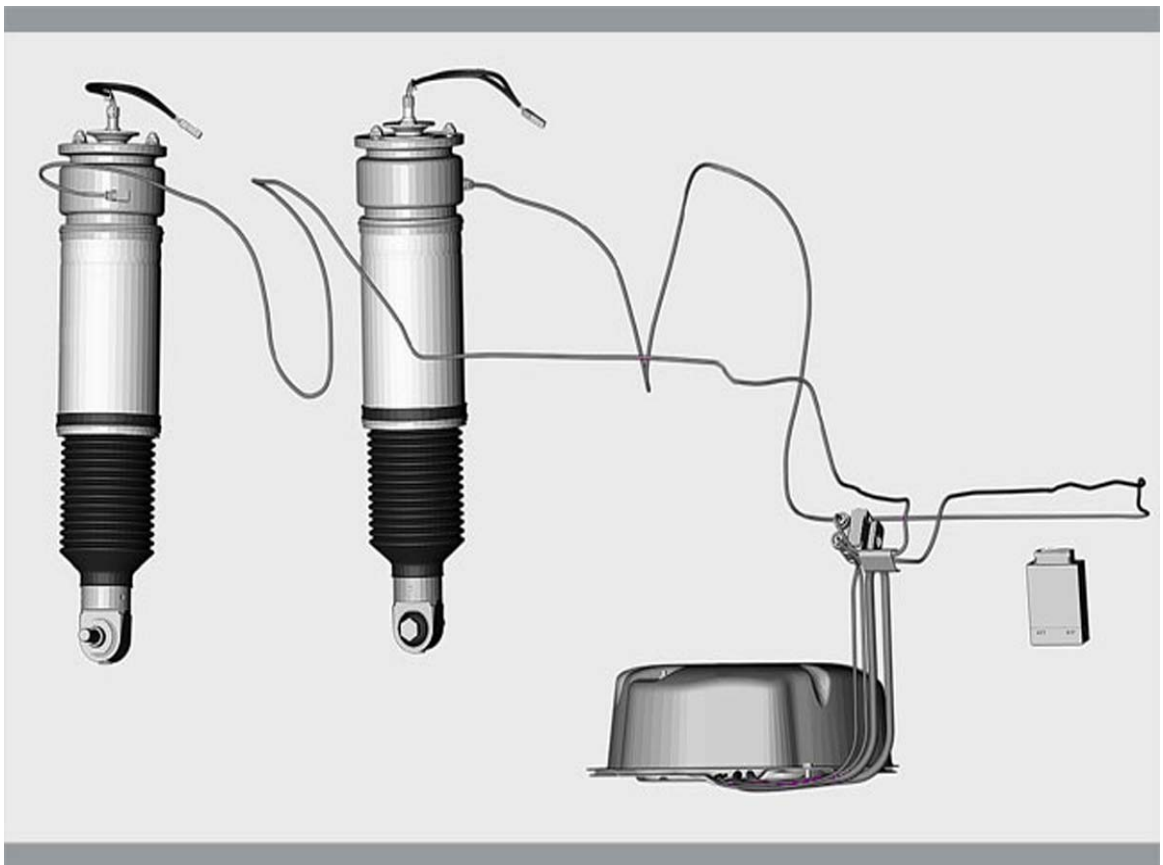



## Components (E65/E66)

### Air Supply Unit (LVA)

The air supply unit is located in the spare tire recess and consists of the following components:

- Protective cover with internal acoustic insulation
- Lid
- Rubber-mounted component carrier
- Compressor Unit
- Compressor Relay (Replaceable)
- Solenoid Valve Block

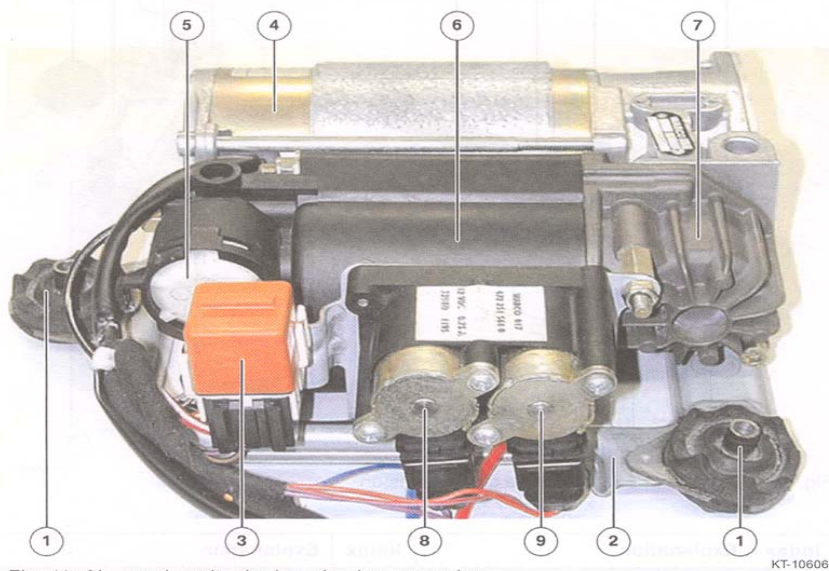

Fig. 11: Air supply unit, single-axle air suspension

Index	Explanation	Index	Explanation
1	Rubber Mount	6	Air Drier
2	Component Carrier	7	Compressor
3	Compressor Relay	8	Solenoid Valve, Right
4	Electric Motor	9	Solenoid Valve, Left
5	Air Cleaner		

## Control Unit

The EHC control module is located in the right rear luggage compartment area in the module carrier next to the battery. On the E65/E66, the control module is connected to the K-CAN S. The EHC control module receives the following information:

- Vehicle Ride Height
- Load Cutout Signal
- Terminal 15 ON/OFF
- Vehicle Speed
- Lateral Acceleration
- “Engine Running” Signal
- Flap Status (Door, Hood, Trunk)

The Control unit decides on a case by case basis whether a control operation is required in order to compensate changes in load. It prevents intervention in the case of other causes. This makes it possible to adapt the frequency, specified height, tolerance thresholds and battery load optimally by means of the control operation to the relevant situation.

In addition to handling the self levelling suspension, the control module monitors the system components as well as storing and displaying faults. The control module has full diagnostic capability.

The EHC module is a 26 pin module with an ELO type connector. The module is connected to the K CAN S. The majority of the input messages are from K CAN S.



**EHC Module Location**



## Air Springs

An identifying feature of the E65/E66 air spring is the internally guided air bellows. Internally guided means that the bellows is guided in an aluminum casing. The bellows is supported on this casing. This prevents the compression forces from weighing heavily on the bellows.

This process allows the bellows to be manufactured from a thin, flexible diaphragm which can react to minimal shocks and in this way provide a more comfortable suspension.

The diaphragm is composed of only one fabric layer embedded in rubber. The fibers within the fabric run longitudinally along the spring strut. The bellows is therefore known as an axial air bellows.

The bottom end of the air spring strut is enclosed in a bellows in order to protect the diaphragm against the mechanical effects of fouling (sand, dirt etc.). The lower end of the bellows incorporates small holes for pressure compensation in the space between the roll piston and bellows. The action of the bellows rolling in this space produces pressure differences.

The bellows together with the roll piston contains a volume of air that is sufficient for optimum suspension.

A residual pressure holding valve on the air spring strut prevents it from being depressurized. The air spring strut remains under pressure in the event of a loss of pressure in the system. The residual pressure is 3.25 +/- 0.75 bar. This ensures that the bellows is not damaged when the car is still being moved.

The residual pressure holding valve is secured with Loctite and must **NOT** be removed.

The air spring strut is initially filled at the manufacturer to 10 bar. This pressure is reduced to 3.5 bar when the spring strut is to be stored. Under this pressure, the strut is extended to maximum length.

The connection of the air spring struts to the air supply unit (distributor block) is located on the left of the luggage compartment under the flap on which the wheel nut wrench is mounted.

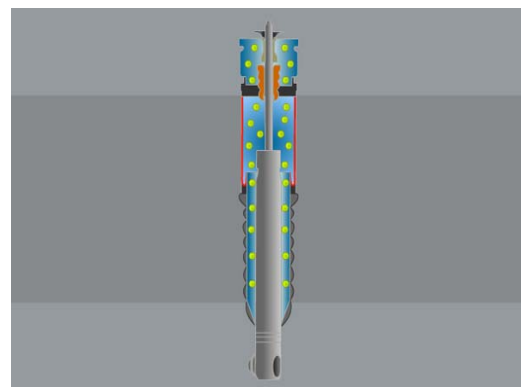
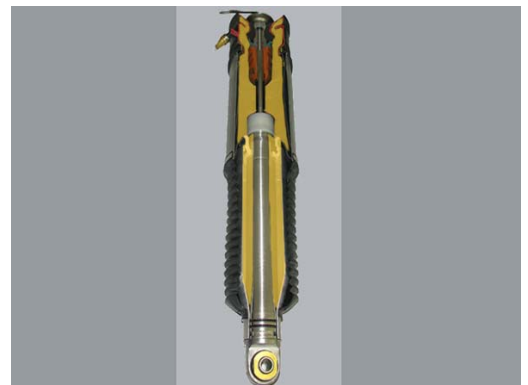

## Ride Height Sensor

There are two ride height sensors, one for each rear wheel. The ride height sensor is actuated by a coupling rod and sends a signal to the EHC control unit.

The sensor is a hall sensor which sends a DC Analog output voltage to the EHC module. The voltage range is approximately .5 to 4.5 volts. The voltage increases with increasing vehicle height and the nominal voltage at normal ride height is approximately 2.5 volts. The right side rear sensor is a double sensor, the additional sensor is an input to the headlight leveling system and has it's own power supply, ground and signal wires.

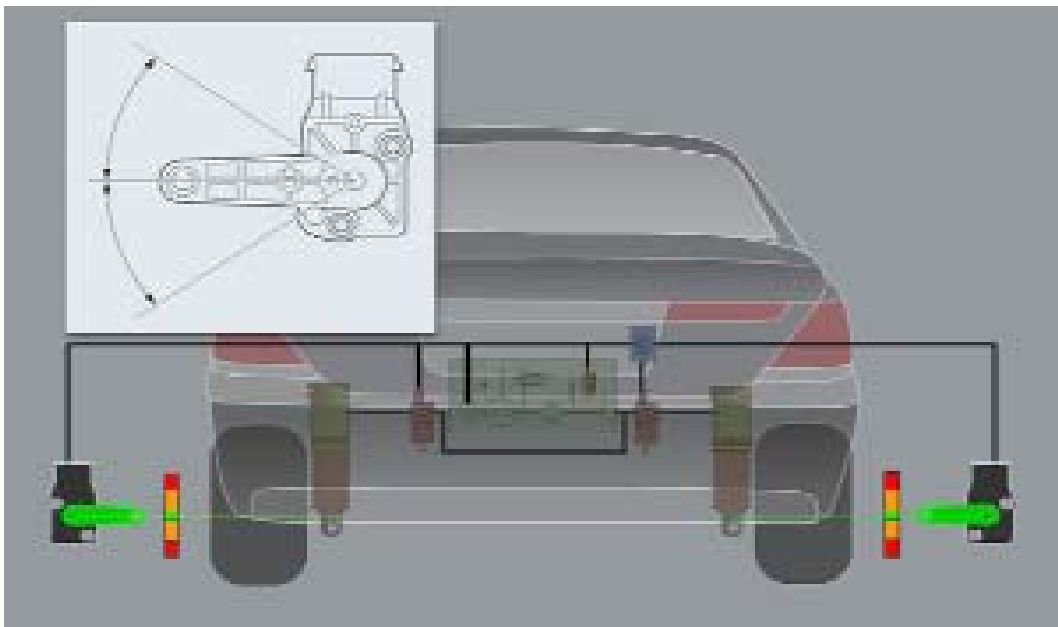

## Check Control Messages

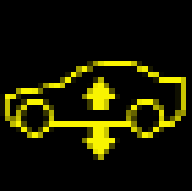
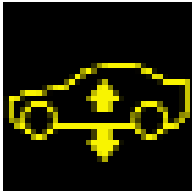
Control Unit	Cause	Variable Telltale Icon	Check Control Message	Information in Control Display
EHC	Alive failure or loss of functionality; transport or belt mode set		Level Control System failure	"Level Control system failure" Ground clearance and driving comfort reduced. Avoid high speed cornering. Have checked by BMW Service as soon as possible.
EHC	Level Control System sensor failure.		Level Control System Fault	"Level Control System fault" Possible reduction in driving comfort. Have problem checked by BMW Service.

---

## Control Mode Flow Chart

The following chart demonstrates the control sequences of the E65/E66 with single axle rear air suspension.

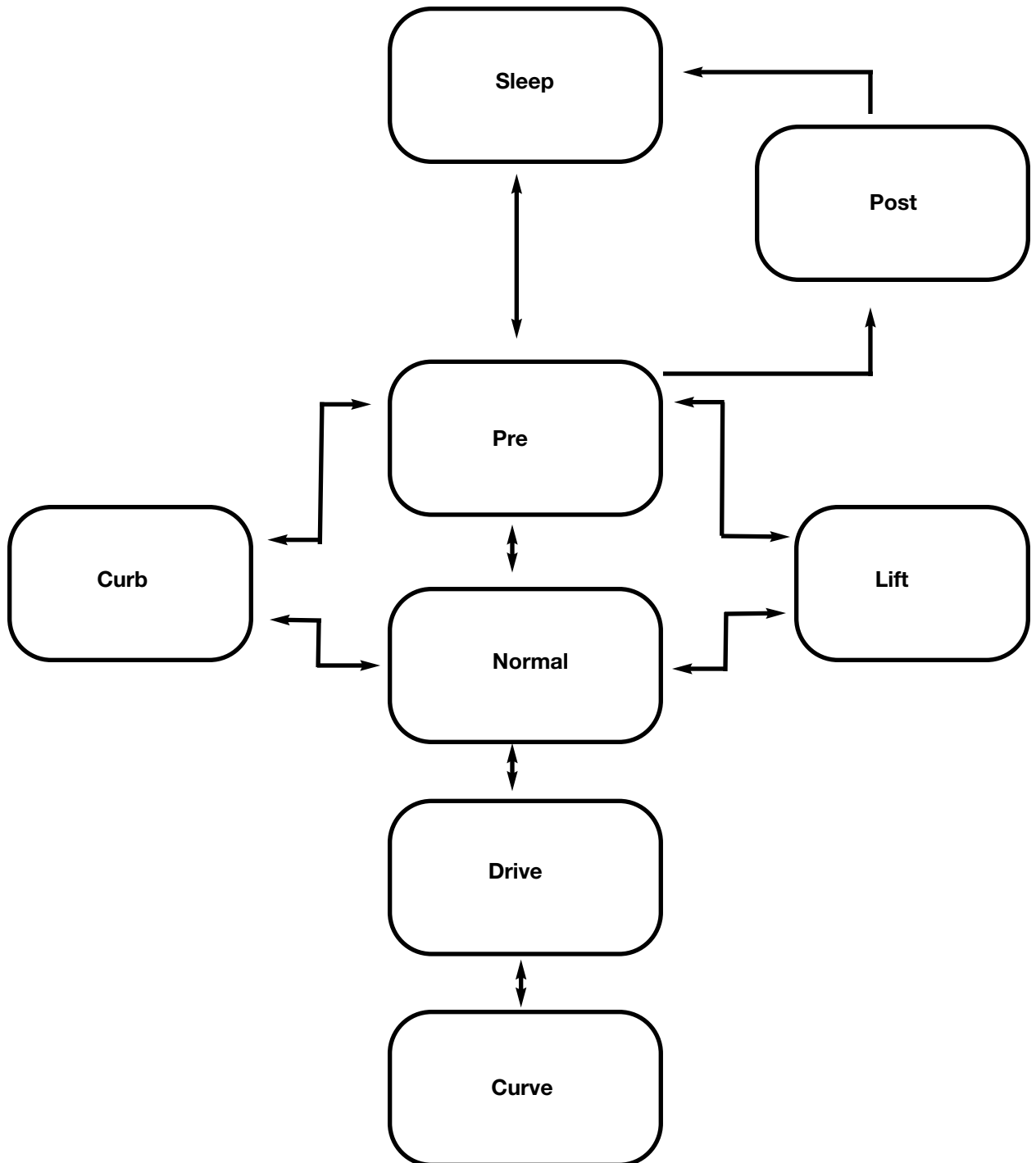



## Principle of Operation

### Control Mode Overview

	E39/E53 EHC I (Single Axle)	E65/E66 (single Axle)	E53 EHC II (Dual Axle)
Sleep	X	X	X
Wake-up			X
Post		X	
Pre	X	X	X
Terminal 15 On			X
Normal	X	X	X
Drive	X	X	X
Curb	X	X	X
Curve	X	X	X
Lift	X	X	X
Twist			X
Trailer			X
Off-Road			X
Access			X

### Control Modes

Ongoing control operations are not affected by transitions from one mode to another. However, in the case of load cutout OFF, control operations are always concluded in order to safeguard system deactivation. The control unit then sets the Sleep Mode.

#### Sleep

The vehicle is in Sleep mode, at the latest, when it has been parked for longer than 16 minutes with a door, hood or rear lid/hatch being operated or the terminal status changing. This is the initial state of the control system. No control operation is being performed in Sleep mode.

The control system goes into Pre-mode when a wake-up signal is received by the control unit.

---

## Post Mode

The Post-mode is adopted in order to compensate any inclination or to adjust the ride height after driving and between the Pre-mode and Sleep mode.

The Post-mode is limited in time to 1 minute. The Post-mode is only executed if the engine has been running before the system switches into this mode. If the engine has not been previously running, the system switches directly from Pre-mode into Sleep mode.

The control operation is performed in a narrow tolerance band of +/- 6mm and is terminated at +/- 4mm. The fast signal filter is used.

In the event of an inclination (Kerb Mode), the control operation takes place for the nominal heights applicable in this situation.

## Pre-Mode

The Pre-mode is activated by the "Load Cutoff" signal (e.g. by opening the door or unlocking with the remote control). The Pre-mode then stays set for 16 minutes and is restarted with a change in status.

The ride height of the vehicle is monitored and evaluated with a wide tolerance band.

In Pre-mode, the vehicle is only controlled to the nominal height if the level is significantly below the nominal height. The control tolerance band is -40mm from the mean value for the single axle air suspension and -20mm for the dual axle system. This control tolerance ensures that the vehicle is only controlled up in the case of large loads in order to increase the ground clearance prior to departure. Small loads give rise to small compression travel and this is compensated only when the engine is started. This control setting helps reduce the battery load.

With the single axle air suspension, the vehicle is controlled down when the mean value derived from both ride height signals is  $> 0\text{mm}$  and one side is in excess of  $+10\text{mm}$ . With twin axle air suspension, the vehicle is controlled down when one side is  $>15\text{mm}$ .

In this mode, only the mean value of the two height signals is considered when deciding whether there is a need for control operation.

The control operation is executed as long as pressure is available in the accumulator. When the accumulator is empty and the engine is turned off, the control operation is driven directly by the compressor. User-activated changes of ride level and filling of the accumulator are not possible.

Control operations which were started in other modes are continued with the inner tolerance bands applicable to these modes.

There is no inclination identification in Pre-mode.

---

## Normal

The normal mode is the starting point for the vehicle's normal operating state. It is obtained by way of the engine running signal.

Ride level compensation, changing the vehicle's ride height and filling the accumulator are possible. The compressor starts up as required.

A narrower tolerance band than that in Pre-mode can be used because the battery capacity does not have to be protected. The fast filter is used with a narrow tolerance band of  $\pm 10\text{mm}$ . In this way, ride level compensation takes place outside a narrow band of  $10\pm 10\text{mm}$ . The faster filter allows the system to respond immediately to changes in ride level. Evaluation and control are performed separately for each wheel.

When a speed signal is recognized, the control unit switches into Drive mode. When the vehicle is stopped, the control unit remains in Drive mode. The system switches back into Normal mode when a door or the boot (trunk) lid is also opened. If none of the doors or the boot lid is opened, the vehicle cannot be loaded or unloaded.

This prevents a control operation happening when the vehicle (for example) is stopped at traffic lights and the ride height is above the mean axle due to the pitching motion on the rear axle.

## Drive

The Drive mode is activated for E39/E53 single axle air suspension when a speed signal of  $>4\text{km/h}$  is recognized. The Drive mode is recognized from  $>1\text{km/h}$  for the E65/E66 single axle air suspension and for the E53 twin-axle air suspension system.

Low pass filters are used. In this way, only changes in ride height over a prolonged period of time (1000 seconds) are corrected. These are merely the changes in ride height, caused by vehicle compression and a reduction in vehicle mass due to fuel consumption. The high pass (fast) filter is used during the control operation. The slow filters are recognized at the end of the control operation. The slow filters are re-initialized at the end of the control operation. The markedly dynamic height signals caused by uneven road surfaces are filtered out.

---

## **Kerb (Curb) Mode**

The Kerb mode prevents the inclination caused by the vehicle mounting an obstacle with one wheel from being compensated. Compensation would cause a renewed inclination of the vehicle and result in a renewed control operation after the vehicle comes off the obstacle.

The Kerb Mode is activated when the height difference between the left and right sides of the vehicle is  $> 32\text{mm}$  for the E65/E66 with single axle air suspension and  $>24\text{mm}$  for the E39/E53 with single axle air suspension and lasts longer than 0.9s. Twisting (also over both axles)  $> 45\text{mm}$  must occur for the E53 with twin axle air suspension.

There must be no speed signal present. The system switches from single wheel control to axle control.

The Kerb mode is quit when the difference between the left and right sides of the vehicle is  $< 28\text{mm}$  for the single axle air suspension and lasts longer than 0.9s when the speed is greater than  $> 1\text{km/h}$ .

If the system switches from Kerb mode to Sleep mode, this status is stored in the EEPROM.

If the vehicle is loaded or unloaded in Kerb mode, the mean value of the axle is calculated by the control unit. The value is calculated in the control unit from the changes in ride level of the spring travel on the left and right sides.

A change in ride level is initiated if the mean value of compression or rebound at the axle is outside the tolerance band of  $\pm 10\text{mm}$ . The left and right sides of the vehicle are raised or lowered in parallel. The height difference between the two sides is maintained.

## **Curve**

Since rolling motions have a direct impact on the measured ride level, an unwanted control operation would be initiated during longer instances of cornering with an appropriate roll angle in spite of the slow filtering of the Drive mode. The control operations during cornering would cause displacement of the air volume from the outer side to the inner side of the curve. Once the curve is completed, this would produce an inclination which would result in a further control operation. The Curve mode prevents this control operation whereby when cornering is recognized slow filtering is stopped and a potential control operation that has started is terminated.

The Curve mode is activated for the E65/E66 single axle EHC and for the E53 twin axle suspension for a lateral acceleration of  $> 2\text{m/s}^2$  and deactivated at  $< 1.5 \text{m/s}^2$ .

The lateral acceleration is recorded by the rotation rate sensor.

---

## Lift

The Lift mode is used to prevent control operations when a wheel is changed or during work on the vehicle while it is on a lifting platform.

This mode is recognized when the permitted rebound travel at one or more wheels is exceeded. For the E65/E66 the limit is > 55mm.

A “jack” situation is also recognized when the ride level is stored and the lowering speed drops below the value of 2 mm/s for 3 seconds.

If the vehicle has been raised slightly and the permitted rebound travel has not yet been achieved, the control operation attempts to readjust the ride height. If the vehicle is not lowered, a car jack situation is recognized after a specific period of time and this ride height is stored.

A reset is performed if the vehicle is again 10 mm below this stored ride height.

## Transport

The Transport mode is set and cleared by means of a diagnosis activation. It serves to increase the ground clearance in order to ensure a safe transportation of vehicles on transporter trucks. The nominal height of the vehicle is raised in this mode by 30 mm.

When the Transport mode is activated, the air suspension symbol is indicated in the variable telltale in the instrument cluster and a text message is output in the Check Control Display.

Control operations do not take place in this mode because the vehicle mass does not change during transportation.

## Belt

The Belt mode is set for mounting on the belt in order to avoid control operations.

When the Belt mode is activated, the air suspension symbol is indicated in the variable telltale in the instrument cluster and a text message is output in the Check Control display.

The Belt mode is cleared by means of a diagnostic activation only. The Belt mode can no longer be set.

New control units are supplied with the Belt mode set.

Control operations are not performed, the safety concept only operates with limited effect.

The Belt Mode is also known as “Band Mode” or “Assembly Line Mode”.

---

## Operating Principle

### Initialization/Reset Performance

When the control unit is powered up after a reset (such as an undervoltage < 4.5 V or by a load cutoff), different tests and initializations are performed. This system is only enabled after the tests have been successfully completed and starts to execute the control programs on a cyclical basis.

Occurring faults are stored and displayed.

### Control Sequence

In an ongoing control operation, the high pass filter (fast filter) is always used to prevent the controlled height from overshooting the nominal value. If a low pass filter (slow filter) were used to calculate the ride height, brief changes of ride height would be consumed. The low-pass filter is used while the vehicle is driven. This type of filtering filters out vibrations which are excited by the road surface.

The high pass filter is used to respond quickly to ride level deviations from setpoint. These take place while the vehicle is stationary in the event of large load changes.

Both sides of the vehicle are controlled individually, i.e. even the setpoint/actual value comparison for both sides is carried out individually. Exception: check for undershooting of the minimum height in Pre-mode and Curb mode: consideration of the left and right mean values in each case.

The following stipulations are applicable here:

- Raising before lowering
- Activation of all valves with control in the same direction
- Individual wheel deactivation

To ensure safe closing of the non-return valve in the air drier, the drain valve is actuated briefly for 200ms after the control operation has ended.

The permissible ON period of the components is monitored while control up operation are executed.

---

## Safety Concept

The safety concept is intended to inhibit any system malfunction, particularly unintentional control operations, through monitoring of signals and function relevant parameters. If faults are detected, the system is switched over or shut down depending on the affected component. The driver is informed of existing faults via the display. Detected faults are stored for diagnostic purposes.

In order to ensure high system availability, existing faults, as far as possible, are cleared with terminal 15 ON. This is done by resetting the fault counter to zero. However, the fault memory content in the EEPROM is retained and can be read out for diagnostic purposes. The system is then operational again. The fast troubleshooting helps to detect existing faults before control operation can take place.

Only lowering is permitted if:

- The permissible supply voltage of 9 volts is undershot
- The permissible compressor running time of 480 seconds is exceeded.

A reset takes place if the voltage is in the OK range of 9 to 16 volts or after the compressor pause time of 100 seconds has elapsed.

Only raising is permitted if:

- The permissible control down period of 40 seconds is exceeded
- The reset takes place the next time the vehicle is driven or after the next control up operation.

No control operation takes place if:

- The permissible supply voltage of 16 volts is exceeded

The reset takes place as soon as the voltage is in the OK range.

---

## Workshop Hints

### Ride Height Measurement

When checking vehicle ride height with EHC, measure from the lower edge of the wheel opening to the center of the wheel hub.

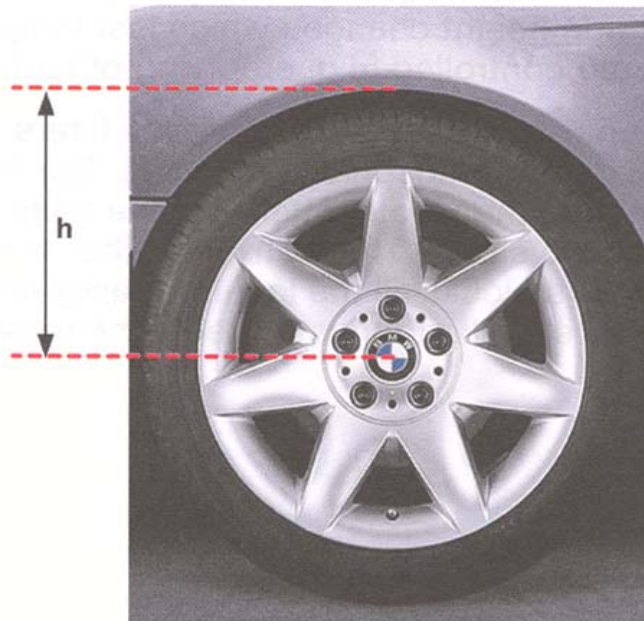

KT-10804

Fig. 23: Ride height measurement (h)



---

## **Diagnosis**

Diagnostic items can be found in the “Control Unit Functions” path when using the DISplus or GT-1. The functions available are Identification (ID page), Read/Clear Fault Memory, Read Test Codes, Diagnosis Requests and Component Activation.

## **Service Functions**

In the Diagnosis Program, there are numerous Service Functions that can be performed for the E65/E66 EHC system. By entering into the “Function Selection” program and following the “Chassis - Pneumatic Suspension” path all of the Service Functions are listed. The Service functions include Ride-Level Offset, Transport Mode and Band Mode.